



INSTRUCTIONS D'ASSEMBLAGE
ASSEMBLY INSTRUCTIONS

MONARCH
SPECIALTIES INC.

I 3094

TABLE D'APPOINT -
NOIR / METAL ARGENT

ACCENT TABLE -
BLACK / SILVER METAL





**POUR DE L'ASSISTANCE OU POUR COMMANDER
DES PIÈCES CONTACTEZ NOTRE DÉPARTEMENT
DE SERVICE À LA CLIENTÈLE.**

**FOR ASSISTANCE OR TO ORDER PARTS
CONTACT OUR CUSTOMER SERVICE DEPARTMENT**

WWW.MONARCHSERVICE.COM

LISTE DES PIÈCES
PARTS LIST

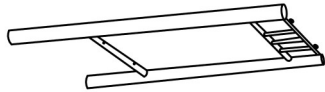
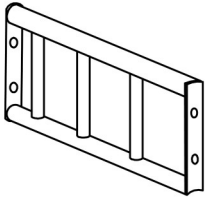
PIÈCE / PART #	IMAGE	DESCRIPTION	QTY / QTÉ
1		<p>TABLE TOP SURFACE DE TABLE</p>	1
2		<p>BOTTOM SHELF ÉTAGÈRE DU BAS</p>	1
3		<p>LEG PATTE</p>	2
4		<p>STRECTHER CHÂSSIS</p>	2

LISTE DES PIÈCES DE MONTAGE
HARDWARE LIST

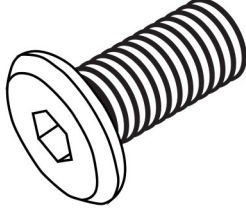
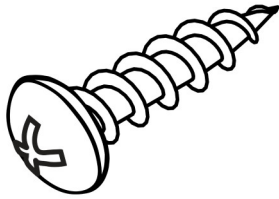
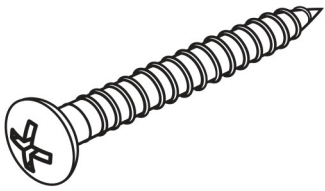
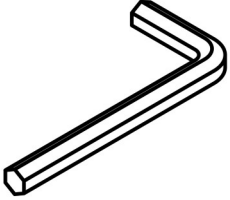
PIÈCE / PART #	IMAGE	DESCRIPTION	QTY / QTÉ
A		<p align="center">ASSEMBLING BOLT - Ø 1/4" X 1/2"</p> <p align="center">BOULON D'ASSEMBLAGE - Ø 1/4" X 1/2"</p>	8
B		<p align="center">ASSEMBLING SCREW - Ø 1/4" X 1/2"</p> <p align="center">VIS D'ASSEMBLAGE - Ø 1/4" X 1/2"</p>	4
C		<p align="center">ASSEMBLING SCREW - Ø 1/4" X 1"</p> <p align="center">VIS D'ASSEMBLAGE - Ø 1/4" X 1"</p>	4
D		<p align="center">HEX KEY</p> <p align="center">CLÉ HEXAGONALE</p>	1



OUTIL DE VÉRIFICATION DE DIMENSIONS DES PIÈCES
HARDWARE DIMENSIONS VERIFICATION TOOL



ÉTAPE / STEP 1

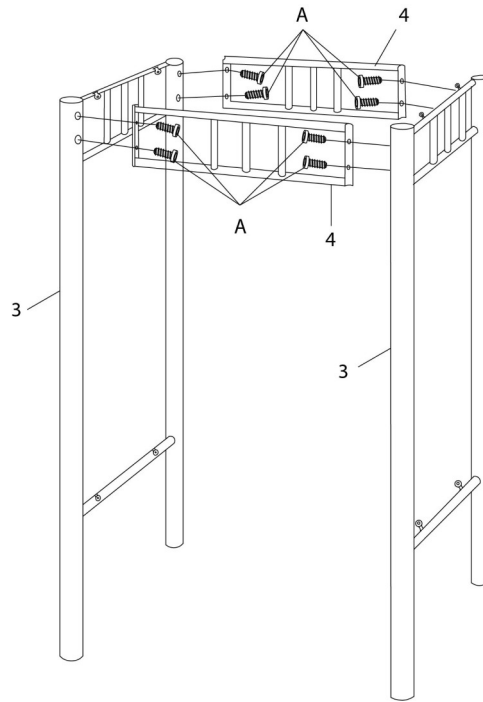

ÉTAPE / STEP 2

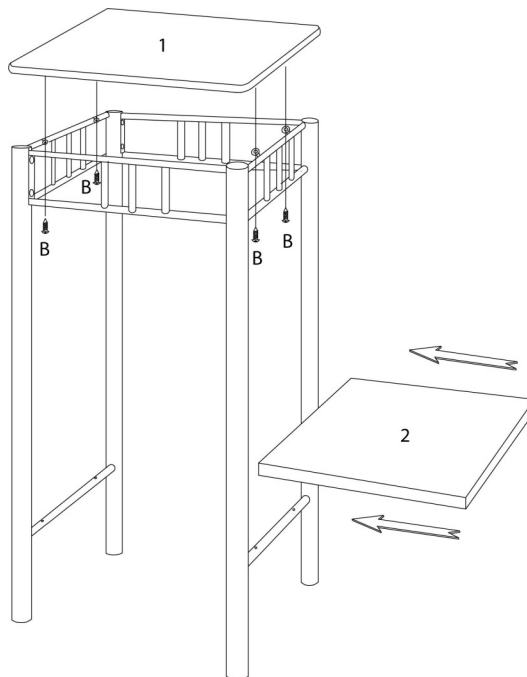

ÉTAPE / STEP 3

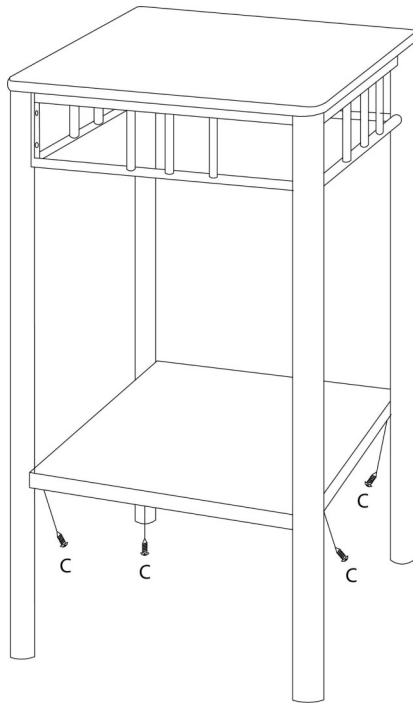

ÉTAPE / STEP 4

